



tecno matrix
Checking fixtures specialists

1. THE COMPANY

2. SERVICES

Machinery Metrology
Machinery

3. PRODUCT LINES

4. SPECIAL FIXTURES

1. THE COMPANY

WHO WE ARE.



- 1927: Family business foundation dedicated to the design and manufacturing of Fixtures.
- Specialists in Quality Control from 1998.
- The R&D department (2005) creation with the objective of discovering new services and products:
 - Data acquisition, analysis & reports
 - New measurement systems
- 2018: Strategic partnership with WITTE Barskamp in Spain business area.
- Currently:
 - Staff: 45
 - R&D Department (Kapture): 12

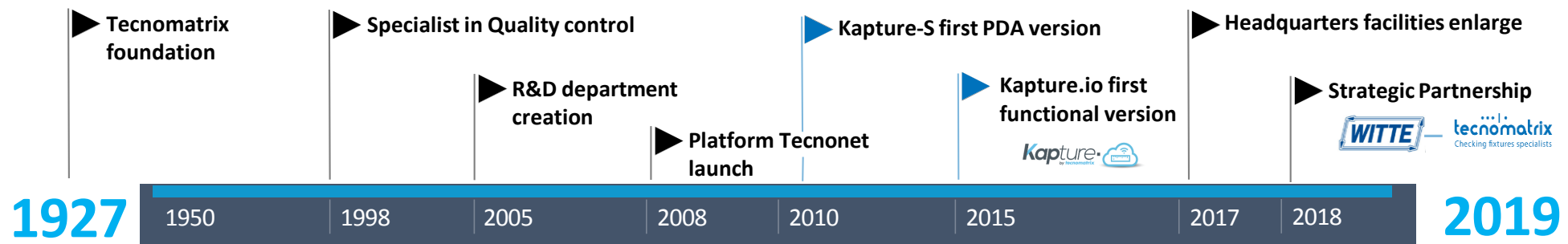

1. THE COMPANY

WHO WE ARE: BUSINESS UNITS

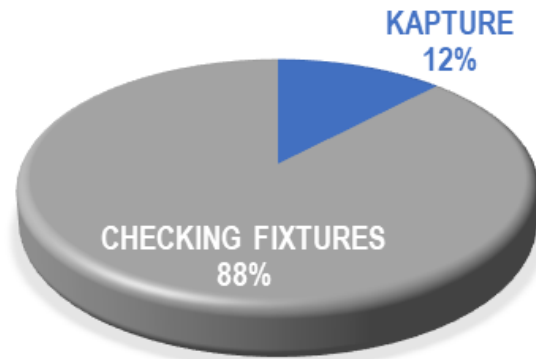

**WEIGHT in TURNOVER
2018**

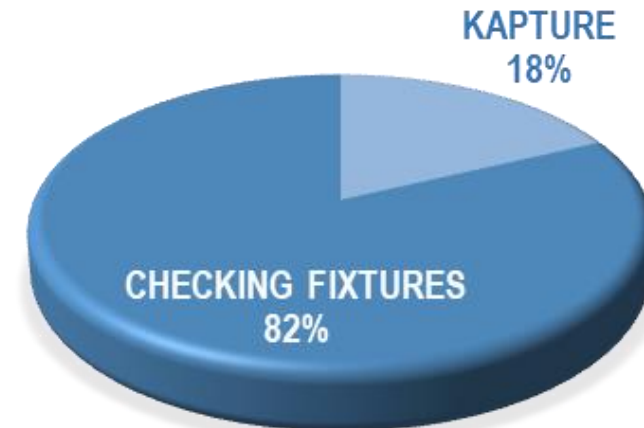

GOAL 2019

1. THE COMPANY

WHERE WE ARE.

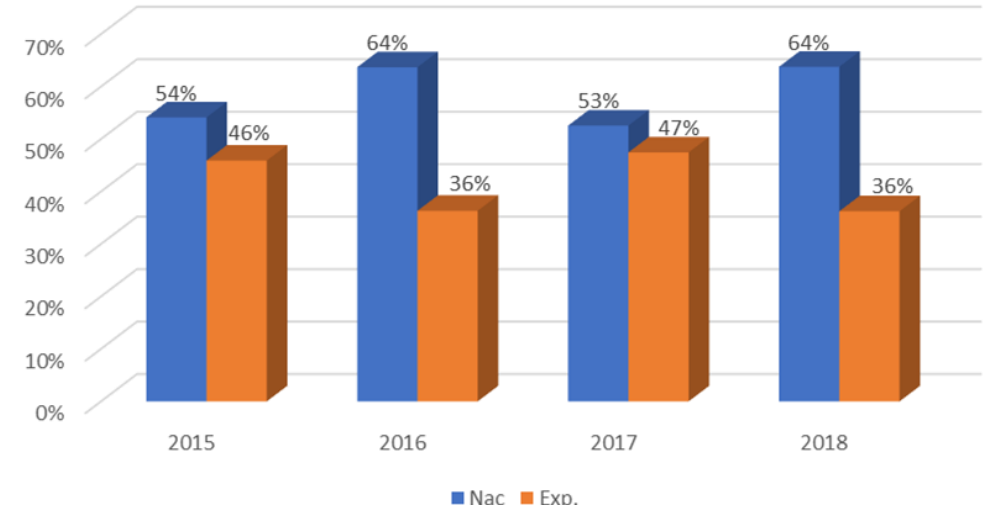

1. THE COMPANY

BRANDS WHO TRUST US.



1. THE COMPANY

WHERE WE GO.

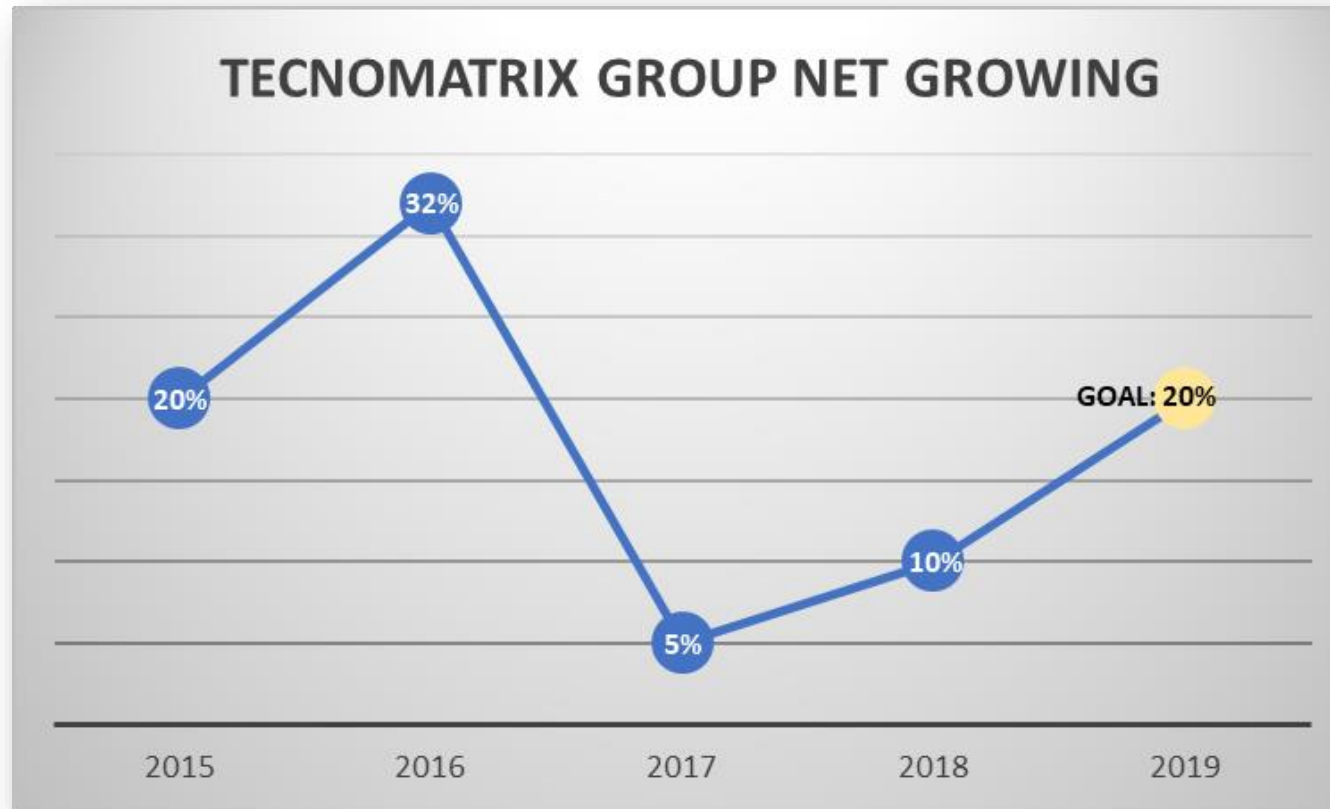

2. SERVICES

ENGINEERING DEPARTMENT

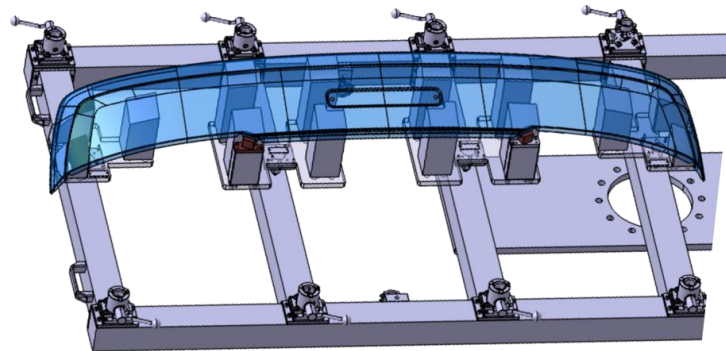
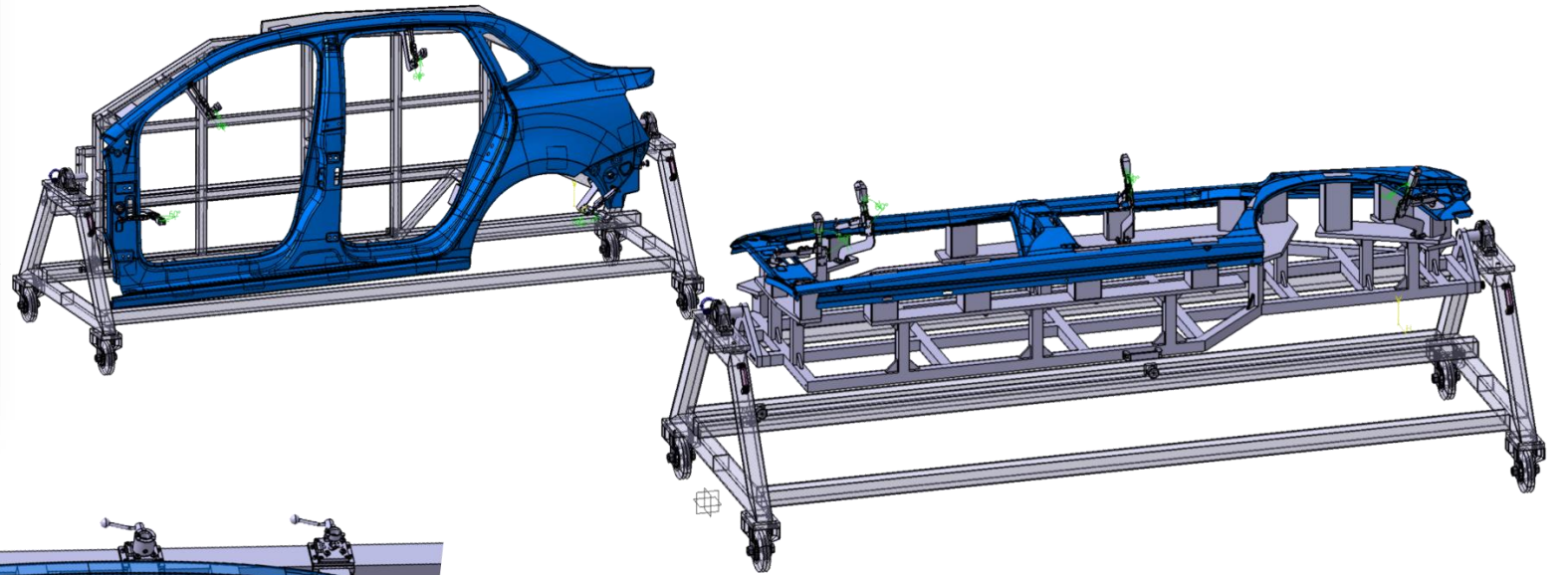

2. SERVICES

MACHINERY METROLOGY



- **4** Metrology rooms

Range: 1200 x 700 x 500 - 4000 x 1600 x 2000



- Vision profile projector.

- Tools, micrometres and gap gauges for manual measurements



2. SERVICES MACHINERY

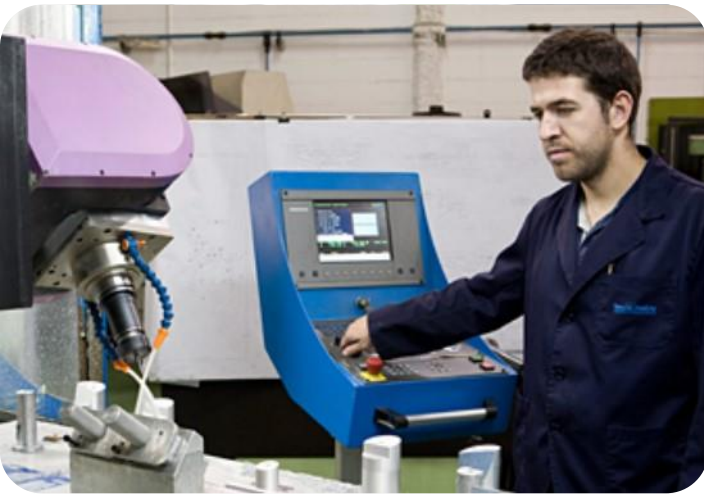

· **3** Milling machine

Range: 1500x800x800 - 4000x1700x1600



· Grinding Machine, Drills, Presses, TIC welder

· Electro-erosion Die-sinking (EDM)



3. PRODUCT LINES

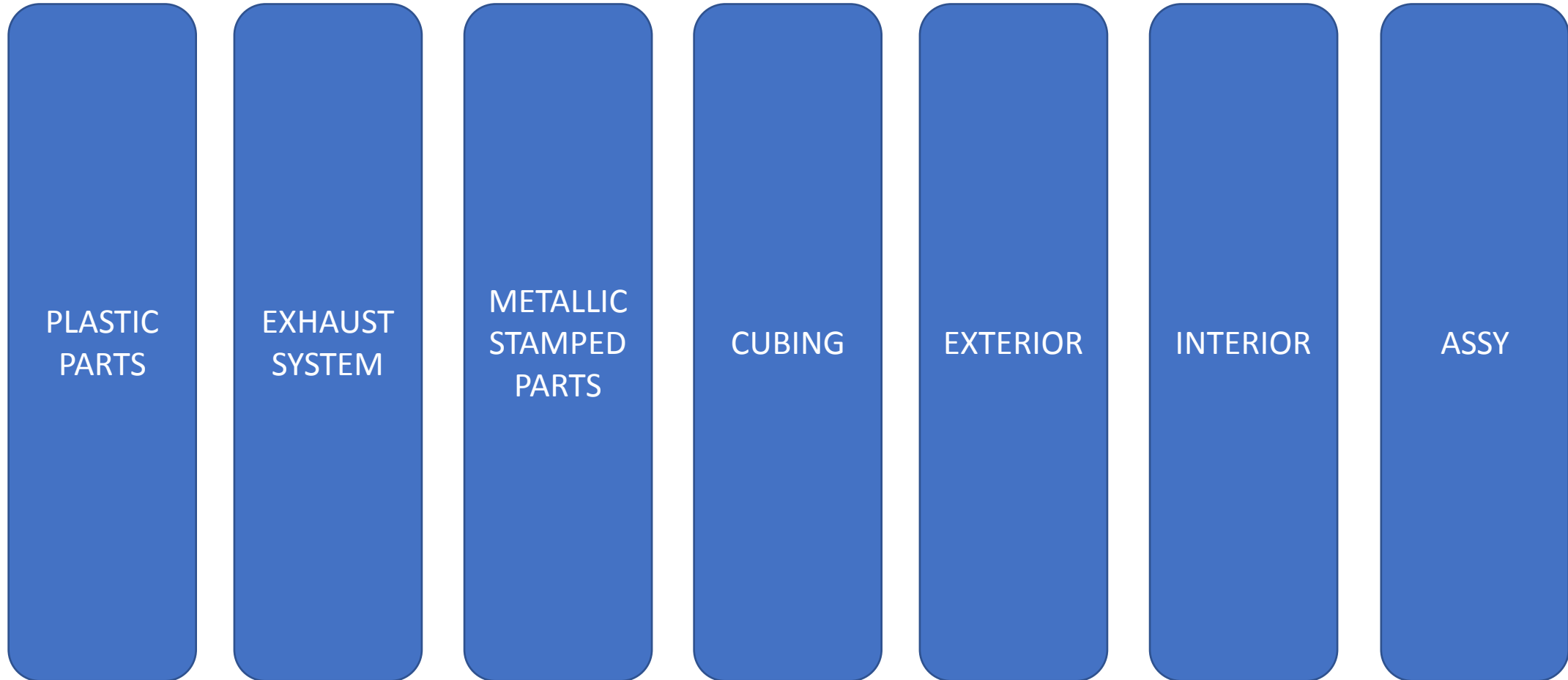

3. PRODUCT LINES: EXAMPLES

PLASTIC
PARTS

EXHAUST
SYSTEM

METALLIC
STAMPED
PARTS

CUBING

EXTERIOR

INTERIOR

ASSY



3. PRODUCT LINES: EXAMPLES

PLASTIC PARTS

EXHAUST SYSTEM

METALLIC STAMPED PARTS

CUBING

EXTERIOR

INTERIOR

ASSY

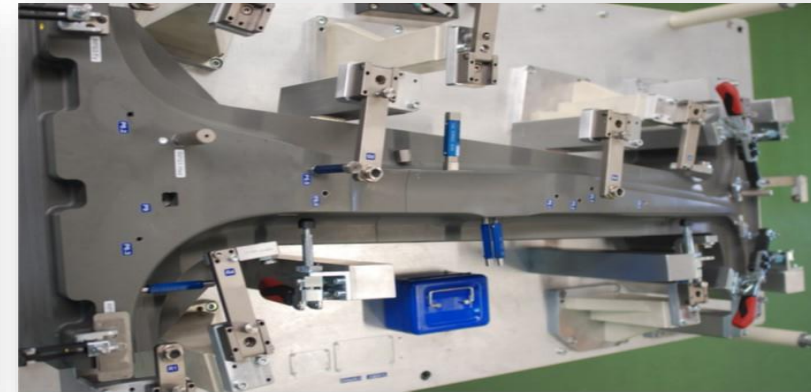
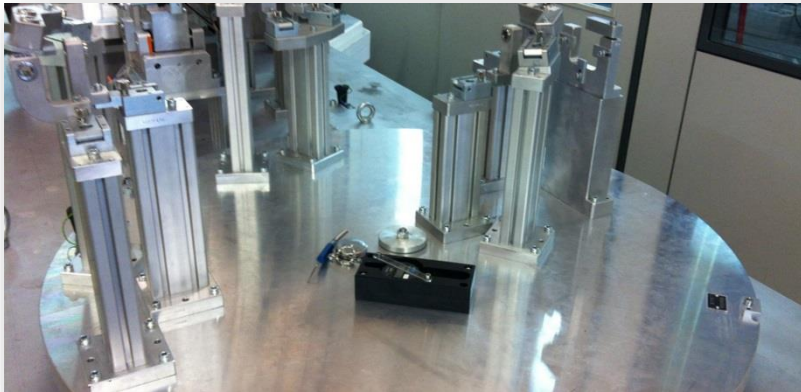
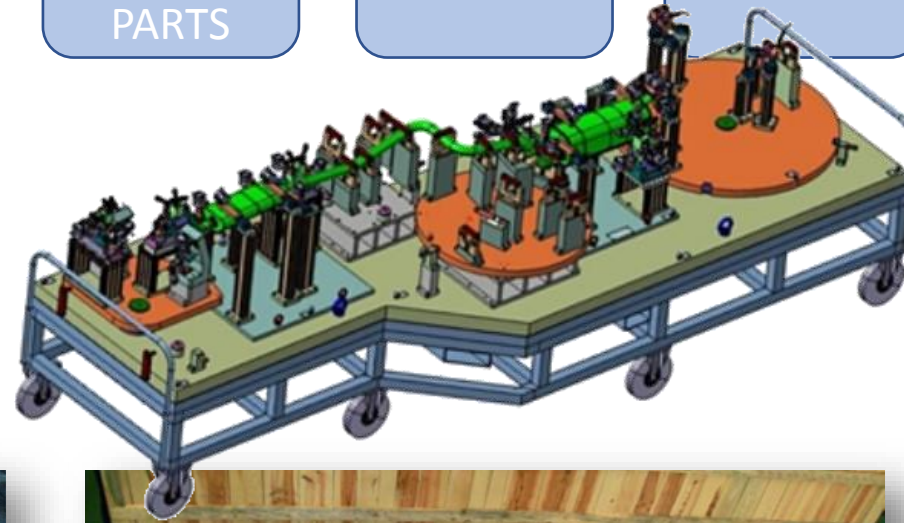

3. PRODUCT LINES: EXAMPLES

PLASTIC
PARTS

EXHAUST
SYSTEM

METALLIC
STAMPED
PARTS

CUBING

EXTERIOR

INTERIOR

ASSY

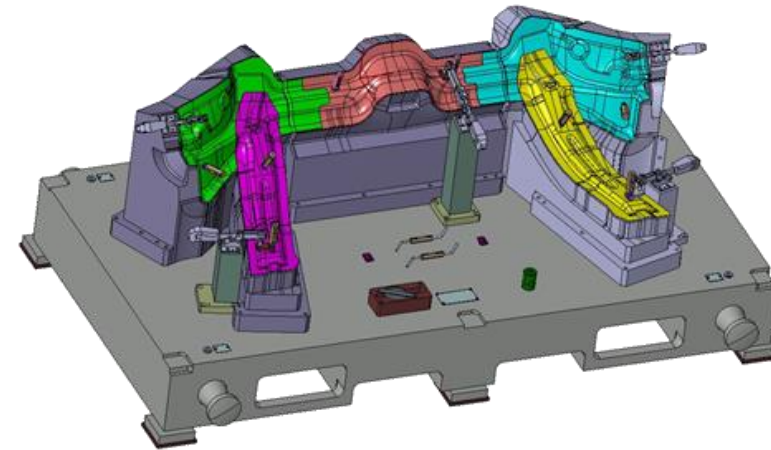
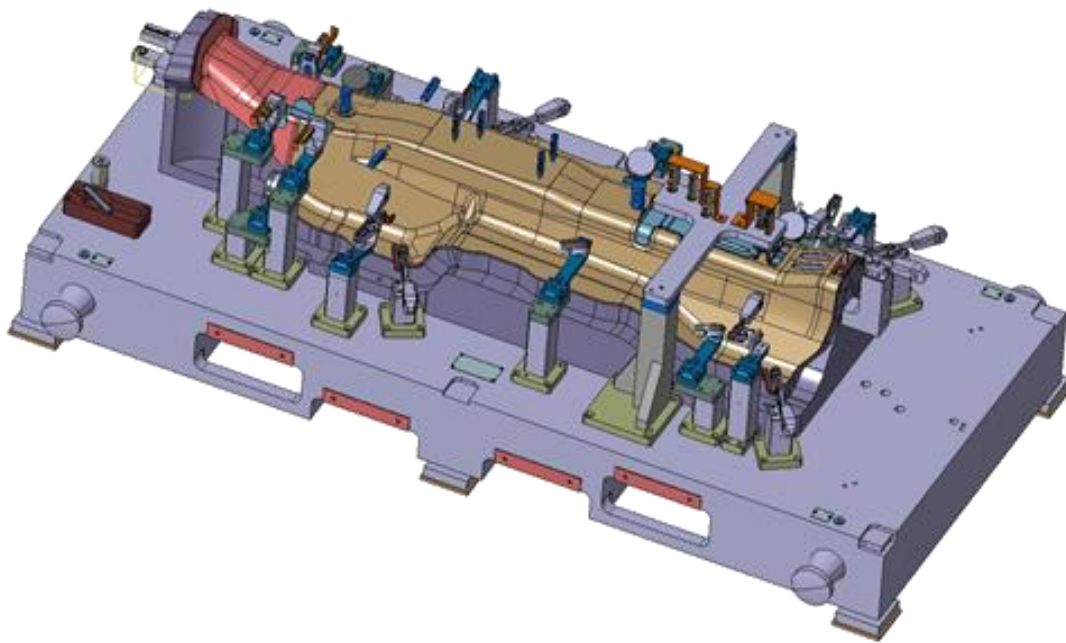

3. PRODUCT LINES: EXAMPLES

PLASTIC PARTS

EXHAUST SYSTEM

METALLIC STAMPED PARTS

CUBING

EXTERIOR

INTERIOR

ASSY

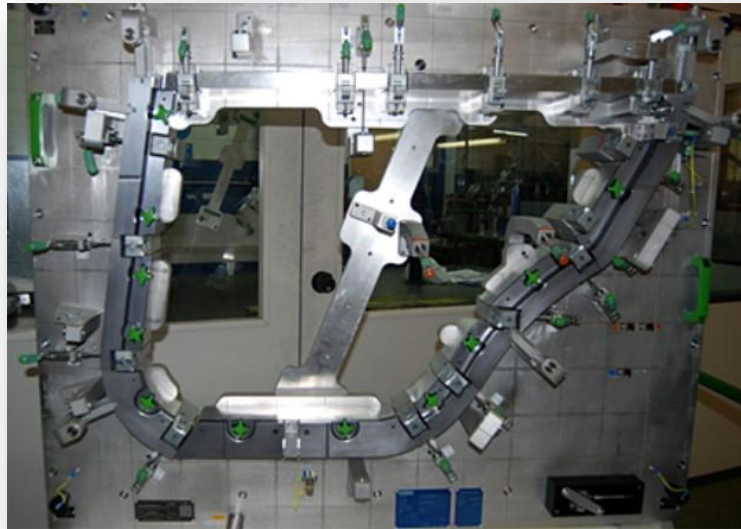
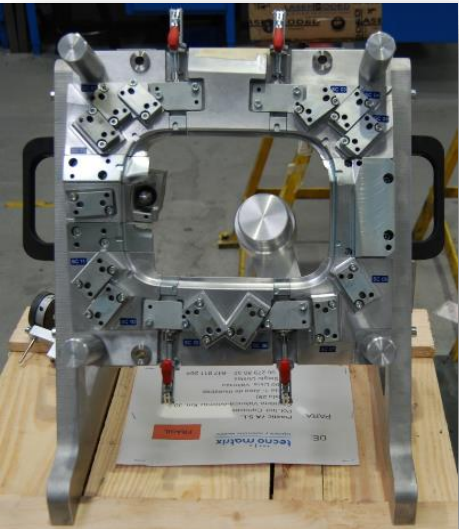

3. PRODUCT LINES: EXAMPLES

PLASTIC
PARTS

EXHAUST
SYSTEM

METALLIC
STAMPED
PARTS

CUBING

EXTERIOR

INTERIOR

ASSY



3. PRODUCT LINES: EXAMPLES

PLASTIC
PARTS

EXHAUST
SYSTEM

METALLIC
STAMPED
PARTS

CUBING

EXTERIOR

INTERIOR

ASSY



3. PRODUCT LINES: EXAMPLES

PLASTIC
PARTS

EXHAUST
SYSTEM

METALLIC
STAMPED
PARTS

CUBING

EXTERIOR

INTERIOR

ASSY



4. SPECIAL FIXTURES

CROSS CAR BEAM (CCB)

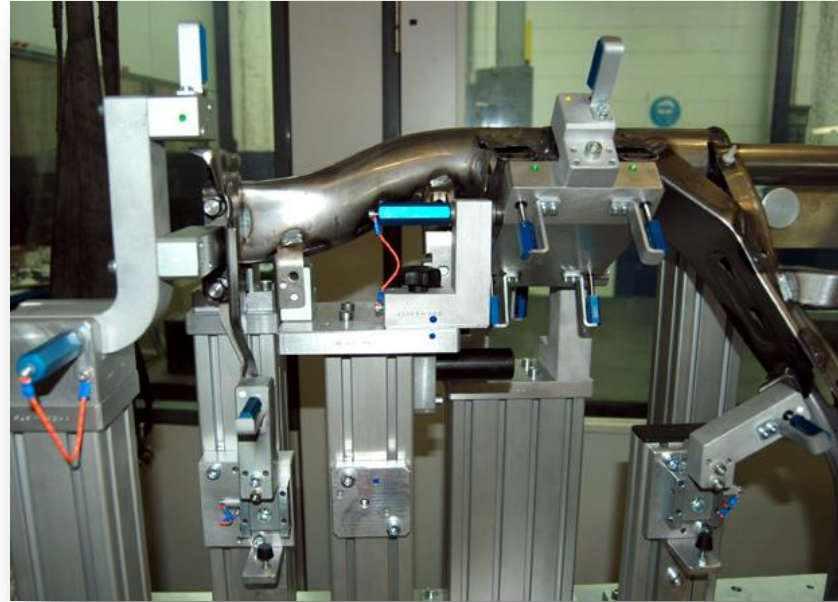
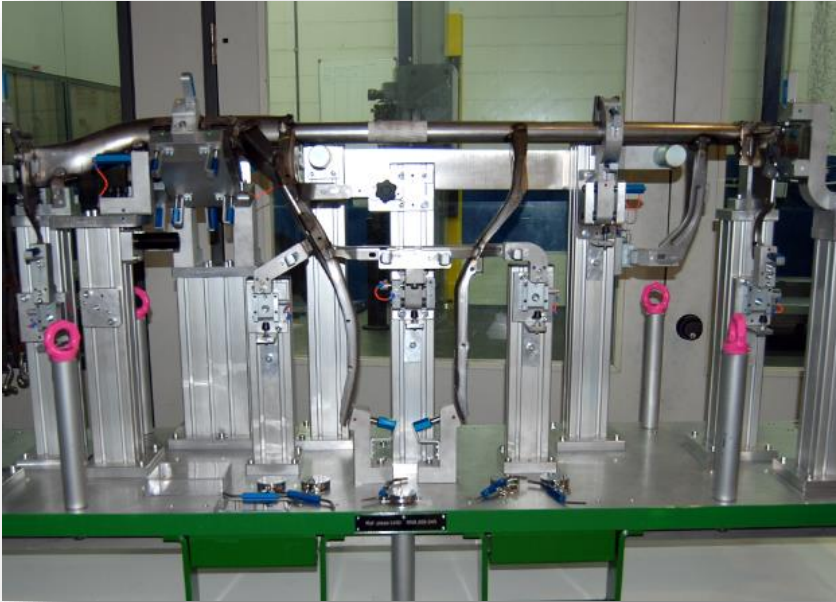

4. SPECIAL FIXTURES

HEADLINERS



4. SPECIAL FIXTURES

WITTE BARSKAMP STRUCTURES

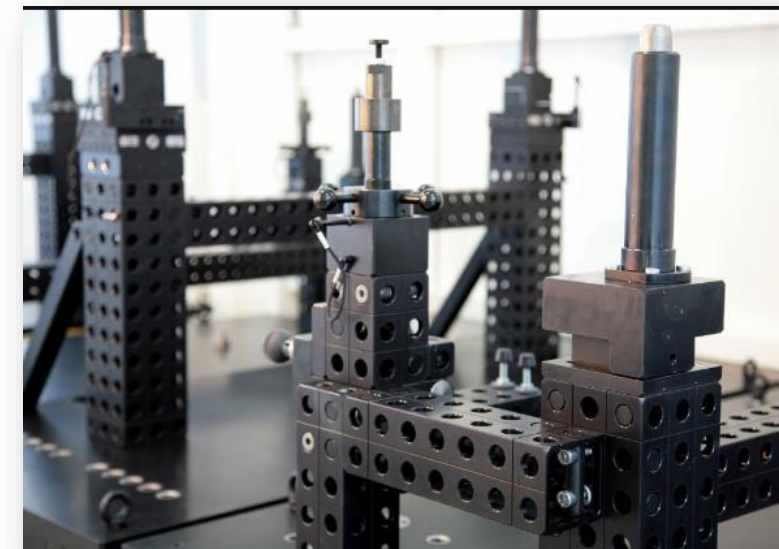
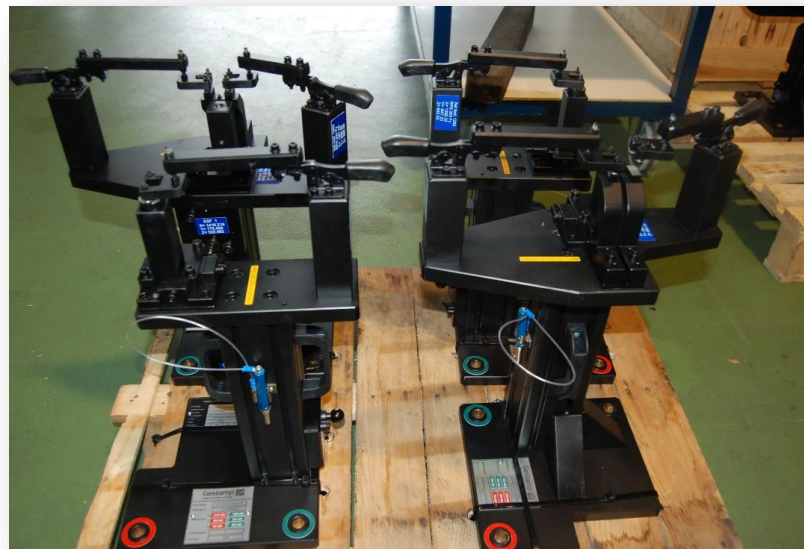
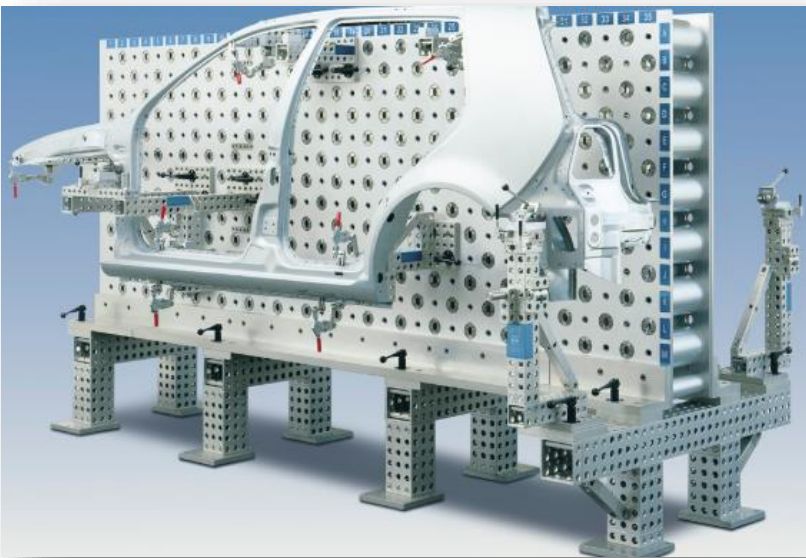

4. SPECIAL FIXTURES

SMART GAGE:
REWORK BENCH + KAPTURE INTEGRATED → 4.0 INDUSTRY!

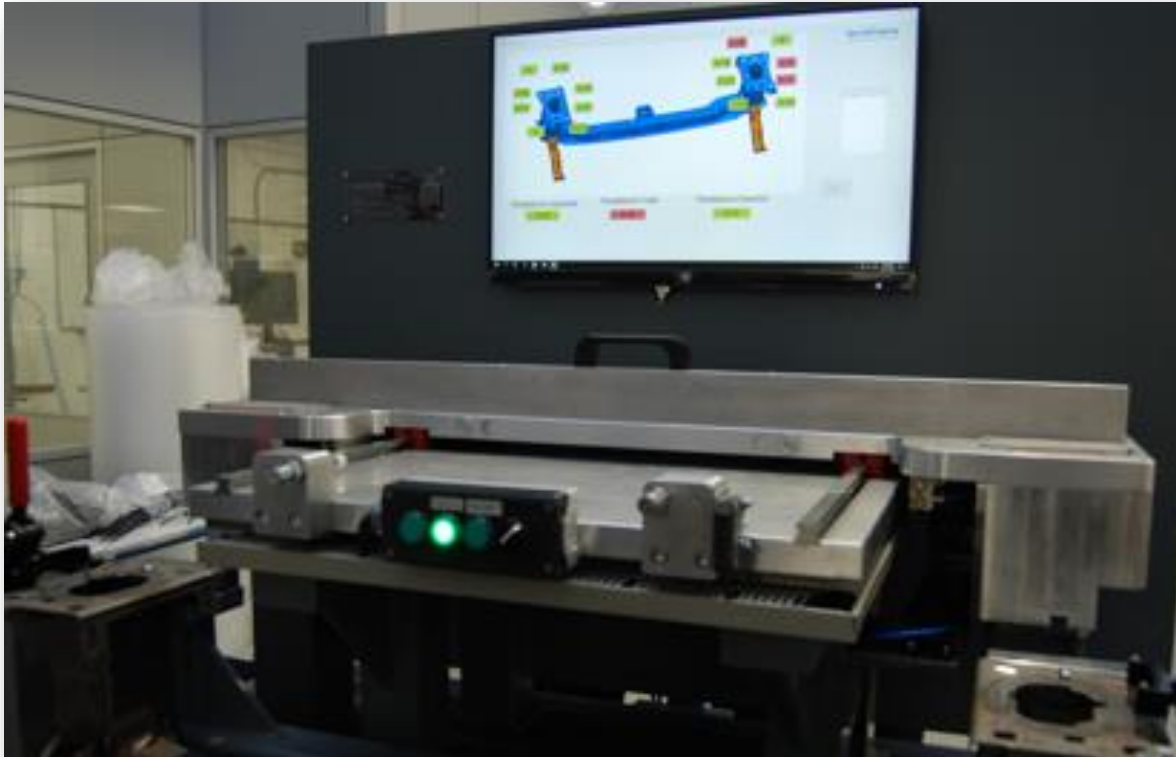

••• Contact

TECNOMATRIX BCN S.L.

Pol. Ind. La Serra 1 - C/ Bergadà 3, Nave 2
08185 Lliçà de Vall (Barcelona)
www.tecnomatrix.com

KAPTURE BY TECNOMATRIX

Camí de Can Gavarra, 2 - Pol. Ind. de Llevant
08217 Polinyà (Barcelona)
www.kapture.io

•••
tecnomatrix****
Checking fixtures specialists

Kapture 
by tecnomatrix



tecno matrix

Checking fixtures specialists